

Features

- * Red Orange and Green chips are matched for uniform light output.
- * T-1 3/4 type package.
- * Long life-solid state reliability.
- * Low power consumption.

Package Dimensions

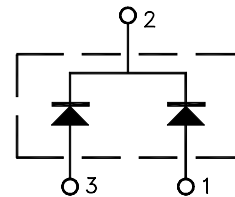
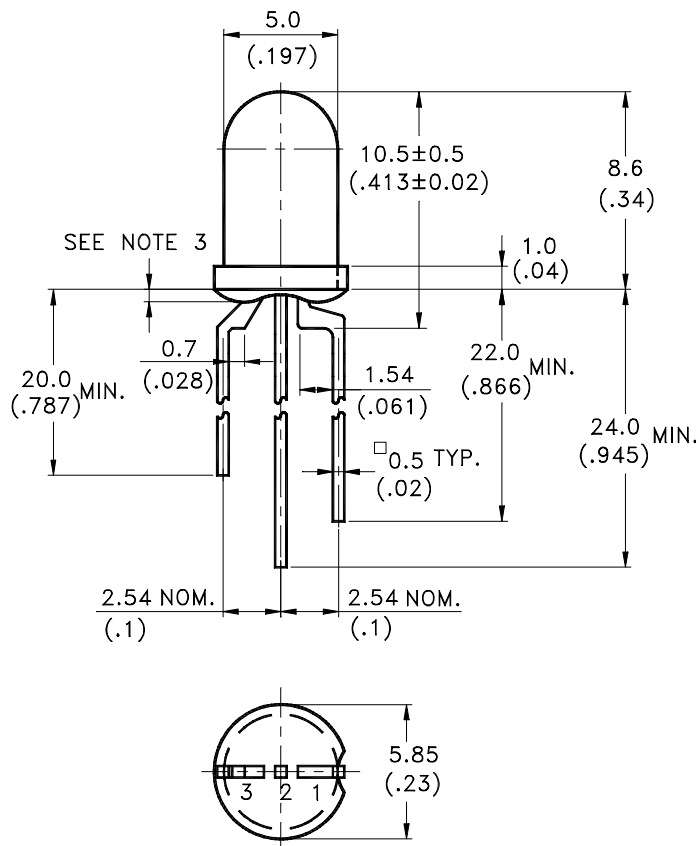

1. Red Orange Anode
2. Common Cathode
3. Green Anode

| Part No. | Lens | Source Color |
|-----------|----------------|--------------------|
| LTL-30EHJ | White Diffused | Red Orange / Green |

Notes:

1. All dimensions are in millimeters (inches).
2. Tolerance is $\pm 0.25\text{mm}(.010\text{'})$ unless otherwise noted.
3. Protruded resin under flange is 1.0mm(.04") max.
4. Lead spacing is measured where the leads emerge from the package.
5. Specification are subject to change without notice.



Absolute Maximum Ratings at $T_A=25^{\circ}\text{C}$

| Parameter | Red Orange | Green | Unit |
|--|---|-------|------------------------|
| Power Dissipation | 100 | 100 | mW |
| Peak Forward Current (1/10 Duty Cycle, 0.1ms Pulse Width) | 120 | 120 | mA |
| Continuous Forward Current | 30 | 30 | mA |
| Derating Linear From 50°C | 0.4 | 0.4 | mA/ $^{\circ}\text{C}$ |
| Reverse Voltage | 5 | 5 | V |
| Operating Temperature Range | -55°C to $+100^{\circ}\text{C}$ | | |
| Storage Temperature Range | -55°C to $+100^{\circ}\text{C}$ | | |
| Lead Soldering Temperature [1.6mm(.063") From Body] | 260 $^{\circ}\text{C}$ for 5 Seconds | | |

Electrical Optical Characteristics at T_A=25°C

| Parameter | Symbol | Color | Min. | Typ. | Max. | Unit | Test Condition |
|--------------------------|-------------------|---------------------|-------------|------------|------------|------|--|
| Luminous Intensity | I _v | Red Orange Green | 12.6 8.7 | 40 29 | | mcd | I _F = 20mA I _F = 20mA Note 1,4 |
| Viewing Angle | 2θ _{1/2} | Red Orange Green | | 30 30 | | deg | Note 2 (Fig.6) |
| Peak Emission | λ _p | Red Orange Green | | 630 565 | | nm | Measurement @Peak (Fig.1) |
| Dominant Wavelength | λ _d | Red Orange Green | | 621 569 | | nm | Note 3 |
| Spectral Line Half-Width | Δλ | Red Orange Green | | 40 30 | | nm | |
| Forward Voltage | V _F | Red Orange Green | | 2.0 2.1 | 2.6 2.6 | V | I _F = 20mA |
| Reverse Current | I _R | Red Orange Green | | | 100 | μA | V _R = 5V |
| Capacitance | C | Red Orange Green | | 20 35 | | pF | V _F = 0, f = 1MHz |

Note: 1. Luminous intensity is measured with a light sensor and filter combination that approximates the CIE (Commission International De L'Eclairage) eye-response curve.

2. θ_{1/2} is the off-axis angle at which the luminous intensity is half the axial luminous intensity.

3. The dominant wavelength, λ_d is derived from the CIE chromaticity diagram and represents the single wavelength which defines the color of the device.

4. The I_v guarantee should be added ±15%.

Property of Lite-On Only

Typical Electrical / Optical Characteristics Curves

(25°C Ambient Temperature Unless Otherwise Noted)

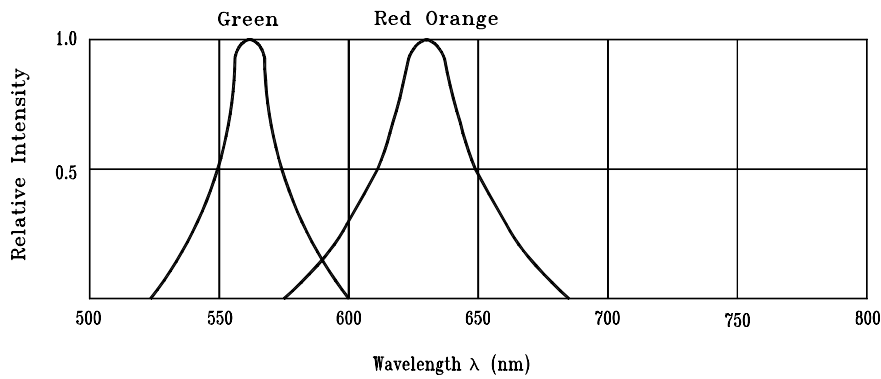

Fig.1 Relative Intensity vs. Wavelength

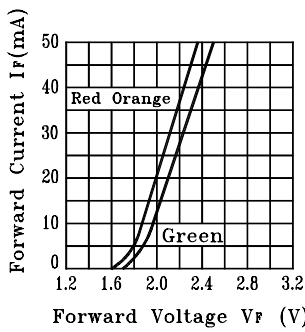

Fig.2 Forward Current vs. Forward Voltage

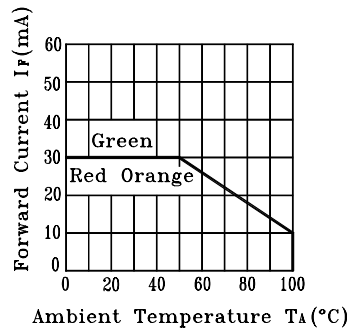

Fig.3 Forward Current Derating Curve

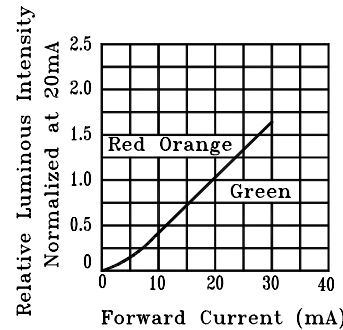

Fig.4 Relative Luminous Intensity vs. Forward Current

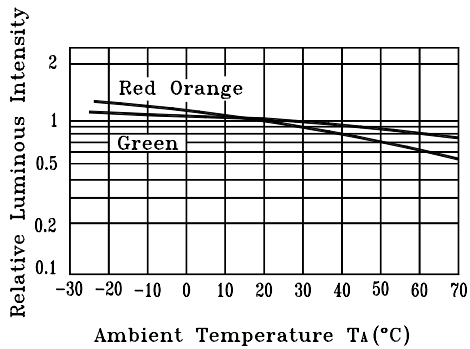

Fig.5 Luminous Intensity vs. Ambient Temperature

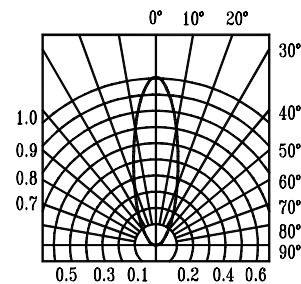

Fig.6 Spatial Distribution